



AMERICAN FLOOR PRODUCTS COMPANY, INC.

AFCO-USA

P.O. BOX 7055 • Gaithersburg, Maryland 20898 -7055 • 301-987-0490 • Fax 301-987-0422
 email: sales@afco-usa.com • Web Site: www.afco-usa.com

CUSTOMER P.O. #

SPACE[®] 2-1/2" x 45° The Invisible Corner Guard (CG-2145)

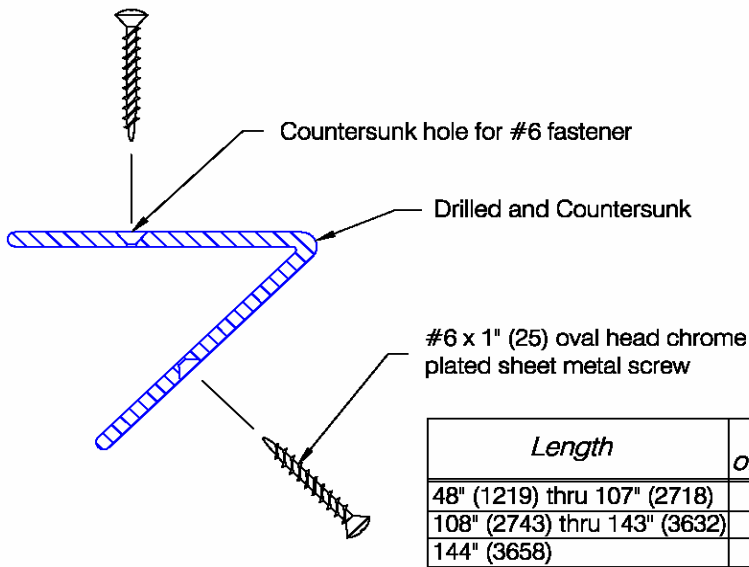
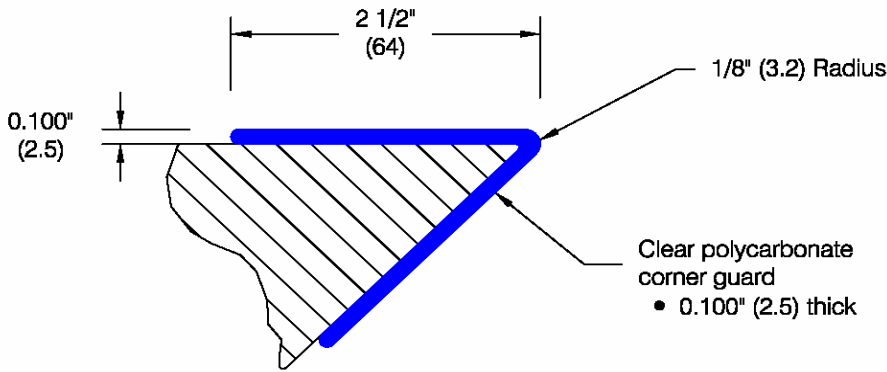

Length	Total # of Screws
48" (1219) thru 107" (2718)	6
108" (2743) thru 143" (3632)	8
144" (3658)	10

Standard Screw Mounted

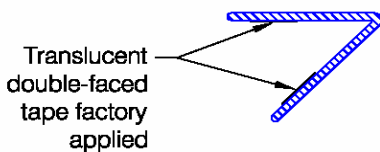
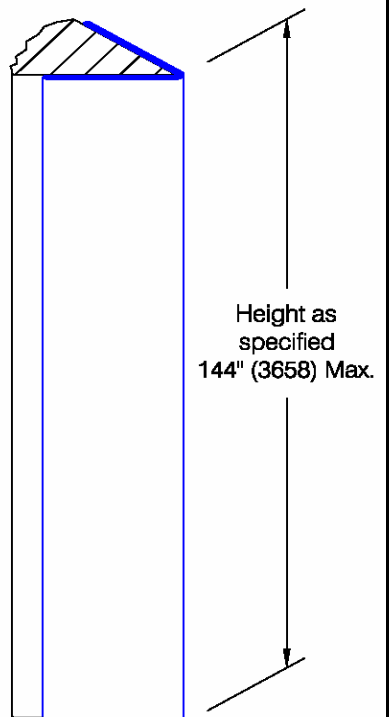

Optional Tape Mounted

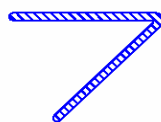

Optional Undrilled

SPACE[®] 2-1/2" x 45° The Invisible Corner Guard (CG-2145)

Mounting	Application	Shock absorbing	Construction	Materials	Fire rating
Surface	High abuse	25.4 ft.lbs/in. ASTM D-256	New and renovation	Extruded lexan [®] Polycarbonate	Class A

Testing in accordance with NFPA 255 (ASTM E 84):

Class A

Flame Spread Index: 5

Smoke Developed Index: 185

<p>Features:</p> <ul style="list-style-type: none"> • Extruded Polycarbonate • U/L 94 Flammability <ul style="list-style-type: none"> V-2 @ 0.125 V-2 @ 0.0625 V-0 @ 0.2500 • Stock lengths: <ul style="list-style-type: none"> 4'-0" (1219 mm), 8'-0" (2438 mm) • Custom lengths available • Mechanical fasteners 	<p>Finishes:</p> <ul style="list-style-type: none"> • Clear #132 smooth finish 	<p>Mounting Options:</p> <ul style="list-style-type: none"> • Double-faced tape • Undrilled (fastening method by others)
---	--	---

Corner Guard designs conform to OSHA, ANSI Life Safety, NFPA, BOCA, UBC, BOMA, ICBO, SBCCI, American Disabilities Act Accessibility Guidelines and all National Building /Code requirements.

	ITEMS	QUANTITY
JOB NAME:		
JOB NUMBER:	Guard Length: 4 ft.	
CONTRACTOR:	8 ft.	
ARCHITECT:	Custom Size:	
DEALER NAME:	Double-Faced Tape:	
SIGNATURE: _____ Date: _____	Undrilled:	